



# **Future Tek, Inc**

**Real-World Trainers for Real-World Jobs**

**Proudly made in the USA in Mississippi since 1997**



**Noel Brock**  
Founder and President  
1997-2008



## Table of Contents

<b>Company Profile</b>	<b>4</b>
<b>Construction</b>	<b>5</b>
Wiring Training Systems	6
Security and Fire Alarm Trainers	18
HVAC Trainers	22
<b>Manufacturing</b>	<b>25</b>
Industrial Motor Controls	26
Programmable Logic Controllers (PLC)	38
Relay Ladder Logic	44
Drive and PanelView Trainers	45
Conveyor Trainers	46
Mechanical Trainers	48
Transformer Trainer	50
Pneumatic Trainers	51
Hydraulic Trainers	52
Process Technology	53
<b>Train the Trainer Program</b>	<b>54</b>
<b>Voltage Requirements</b>	<b>55</b>

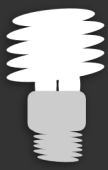

# Real World Trainers for Real World Jobs

## Company Profile

Future Tek, Inc. is headquartered in Columbus, MS and has been in operation since 1997. Each Future Tek trainer is designed utilizing years of industrial and classroom experience. This dual perspective leads to the development of trainers that provides students with “real world,” “hands-on” experiences producing highly qualified graduates.

## Service

Service is our first priority. We pride ourselves in providing excellent customer service and technical support. All models come with 24/7 technical support for as long as you own the equipment.

## Cutting Edge Technology

Our training line is continuously updated and expanded to meet today’s rapidly changing technology needs.

## Reliability

Future Tek trainers are made to last. Designs allow repeated use and stand the test of time.

## Versatility

Our trainers are manufactured in the U.S.A. All designs allow modification to meet your specific needs.



Scan this code  
and like us on

facebook

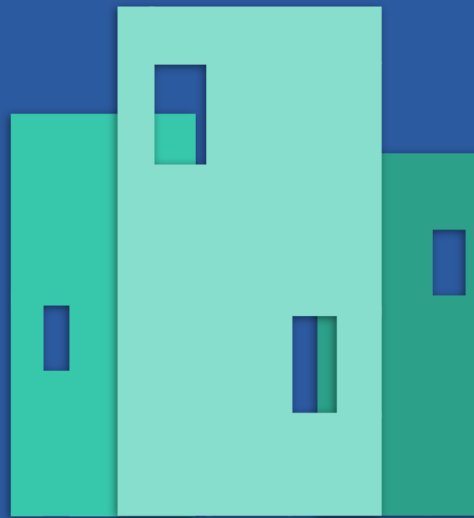

# Construction

## **Construction Industry**

The Construction Industry has always been a big player in the American economy. Future Tek, Inc. provides a number of training systems designed to produce skilled technicians ready to join the workforce.

Future Tek Trainers designed for the Construction Industry include:

- Model 8000 Residential Wiring Training Package
- Model 9000 Commercial/Industrial Wiring Training Package
- CWT Series of Commercial Wiring Training Systems
- Model 1800/1801 Residential Wiring Training System
- Model 7600 ATS Generator Training System
- Model 4000 Home Security Workstation
- Model 4200 Commercial/Industrial Fire Alarm Workstation
- Model 2000-WS Residential/Commercial/Industrial Lighting Trainer
- Models 7130 and 4210 HVAC Training Systems



## Wiring Training Systems

### Model 8000 Residential Wiring Workstation

The training package includes:

- Desktop Rack (Model 5100)
- (3) Single pole switch modules (Model 800)
- (2) Three way switch modules (Model 801)
- Four way switch module (Model 802)
- Single pole rotary dimmer switch module (Model 803)
- (2) Keyless light fixture modules (Model 804)
- (2) Duplex receptacle modules (Model 805)
- Split circuit receptacle module (Model 806)
- GFCI receptacle module (Model 807)
- Dryer receptacle module (Model 808)
- Range receptacle module (Model 809)
- Telephone outlet module (Model 810)
- (2) Smoke alarm modules (Model 811)
- Door Chime Module (Model 812)
- Four circuit breaker panel module with 2 lockouts (Model 813)
- Service entrance module (Model 814)
- Three way rotary dimmer switch module (Model 815)
- Bathroom vent fan module (Model 816)
- GFCI protection module (Model 819)

### Optional Equipment

- Motion sensor module (Model 817)
- Dusk to dawn module (Model 818)
- Residential wiring fault module (Model 1301)



800



801



802



803

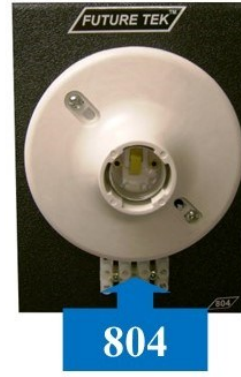

804



805



806



807



808



809



810



811

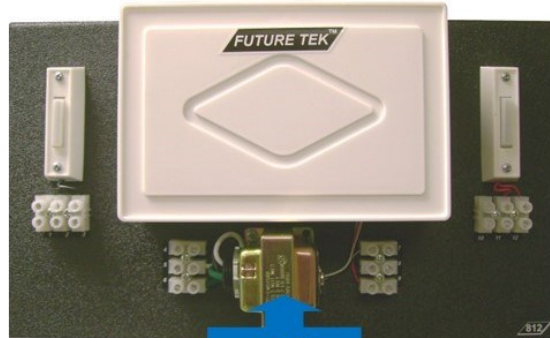

812



813



814



815



816



817



818



819

## Residential Wiring Troubleshooting Package



### Model 8000 –TS Basic Residential Wiring Training System with Troubleshooting Capabilities

- Desktop Rack (Model 5100)
- Single Pole Switch Module (Model 800)
- Single Pole Switch Module with Troubleshooting (Model 800-F1)
- Single Pole Switch Module with Troubleshooting (Model 800-F2)
- Three-Way Switch Module with Troubleshooting (Model 801-F1)
- Three-Way Switch Module with Troubleshooting (Model 801-F2)
- Four-Way Switch Module with Troubleshooting (Model 802-F1)
- Single Pole Rotary Dimmer Switch Module (Model 803)
- Keyless Light Fixture Module with Troubleshooting (Model 804-F1)
- Keyless Light Fixture Module with Troubleshooting (Model 804-F2)
- Duplex Receptacle Module with Troubleshooting (Model 805-F1)
- Duplex Receptacle Module with Troubleshooting (Model 805-F2)
- Split Circuit Receptacle Module (Model 806)
- Ground Fault Circuit Interrupter (GFCI) Receptacle Module with Troubleshooting (Model 807-F)
- Dryer Receptacle Module (Model 808)
- Range Receptacle Module (Model 809)
- Telephone Outlet Module (Model 810)
- (2) Smoke Alarm Modules (Model 811)
- Door Chime Module with Troubleshooting (Model 812-F)
- Four Circuit Breaker Panel Module with 2 Lock Outs (Model 813)
- Service Entrance Module (Comes with watt-hour meter, 15' of SO Cord, and 4-Wire male and female twist lock plug) (Model 814)
- Three-Way Rotary Dimmer Switch Module (Model 815)
- Bathroom Vent Fan Module (Model 816)
- GFCI Protection Module (Model 819)
- Master Fault Controller with Communications Module (Model 8000-Master)



## Advanced Residential Wiring Training System with Troubleshooting

- Desktop Rack (Model 5100)
- Single Pole Switch Module (Model 800)
- Single Pole Switch Module with Troubleshooting (Model 800-F1)
- Single Pole Switch Module with Troubleshooting (Model 800-F2)
- Three-Way Switch Module with Troubleshooting (Model 801-F1)
- Three-Way Switch Module with Troubleshooting (Model 801-F2)
- Four-Way Switch Module with Troubleshooting (Model 802-F1)
- Single Pole Rotary Dimmer Switch Module with Troubleshooting (Model 803-F)
- Keyless Light Fixture Module with Troubleshooting (Model 804-F1)
- Keyless Light Fixture Module with Troubleshooting (Model 804-F2)
- Duplex Receptacle Module with Troubleshooting (Model 805-F1)
- Duplex Receptacle Module with Troubleshooting (Model 805-F2)
- Split Circuit Receptacle Module with Troubleshooting (Model 806-F)
- Ground Fault Circuit Interrupter (GFCI) Receptacle Module with Troubleshooting (Model 807-F)
- Dryer Receptacle Module with Troubleshooting (Model 808-F)
- Range Receptacle Module with Troubleshooting (Model 809-F)
- Telephone Outlet Module with Troubleshooting (Model 810-F)
- Smoke Alarm Module (Model 811)
- Smoke Alarm Module with Troubleshooting (Model 811-F)
- Door Chime Module with Troubleshooting (Model 812-F)
- Four Circuit Breaker Panel Module with 2 Lock Outs (Model 813)
- Service Entrance Module (Comes with watt-hour meter, 15” of SO Cord, and 4-Wire male and female twist lock plug) (Model 814)
- Three-Way Rotary Dimmer Switch Module with Troubleshooting (Model 815-F)
- Bathroom Vent Fan Module (Model 816)
- Dusk to Dawn Module with Troubleshooting (Model 818-F)
- GFCI Protection Module (Model 819)
- Master Fault Controller with Communications Module (Model 8000-Master)

### Optional Add-ons:

- Motion Sensor Module (Model 817)
- Dusk to Dawn Module (Model 818)
- Desktop Rack with 2 Sliding work Shelves (Model 5100-S)
- Mobile Cart (Model 5102)
- Residential Wiring Fault Module (Model 1301)



## Wiring Training Systems

### Model 9000 Commercial and Industrial Workstation

The training package includes:

- Desktop Rack (Model 5100)
- (2) Single pole switch modules (Model 910)
- (2) Three way switch modules (Model 911)
- Four way switch module (Model 912)
- Single pole rotary dimmer switch module (Model 913)
- (2) Three way rotary dimmer switch modules (Model 914)
- (2) Keyless light fixture modules (Model 915)
- Duplex receptacle module (Model 916)
- Split circuit receptacle module (Model 917)
- (2) GFCI receptacle modules (Model 918)
- Smoke Detector Module (Model 919)
- 230 volt single receptacle module (Model 920)
- Motion detector module (Model 921)
- Dusk to dawn photoelectric sensor module (Model 922)
- Tork timer module (Model 923)
- Single phase four circuit breaker panel module (Model 924)
- Three phase source voltage module with lockout tagout (Model 925)
- Three phase disconnect module (Model 926)
- Industrial finger safe control transformer module (Model 927)
- AB start/stop station module (Model 928)
- AB E-stop module (Model 929)
- Indicator light module (1 red & 1 green) (Model 930)
- Three phase motor starter module (Model 931)
- Three phase AC motor (Model 932)

# Building tomorrow's landmarks



910



911



912



913



914



915



916



917



918



919



920



921



922



923



924



925



926



927



928



929



930

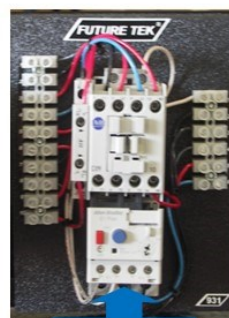

931

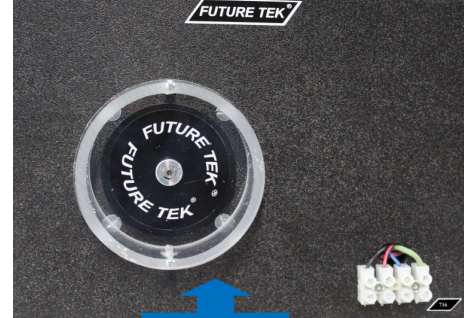

932

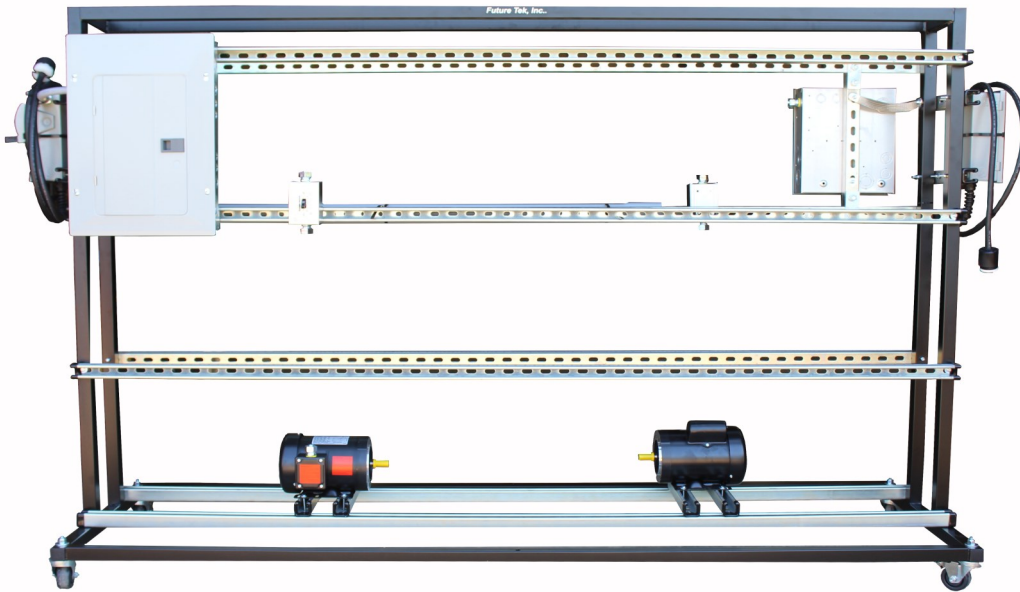

## Wiring Training Systems

### CWT Series (Commercial Wiring Training Systems)

The CWT line of trainers are unique in that they provide real interactive training which includes physically connecting industry parts and electrical devices. These trainers use real industry components and allow the student to experience what is actually encountered in the field.

#### **Basic Conduit Installation (CWT100)**

*Includes all of the following components:*

- (2) 100 amp 8 space single phase panels
- 15 amp single pole breaker
- 20 amp single pole breaker
- NEMA 6" x 6" enclosure
- 36" NEMA 1 wireway 4" x 4"
- (20) 1/2" EMT strut clamps w/saddle
- (20) 1/2" EMT box connectors
- (30) Caddy® slick nuts
- (20) 1/2" conduit hangers
- (30) 1/4" x 1" cap screws
- (2) 1/2" EMT corner couplings
- (10) 4" x 2" metal handy boxes, single gang
- (8) 4" x 4" metal boxes, two gang
- (6) 4" octagon boxes
- (2) 2" universal pipe straps
- (5') 2" rigid PVC
- (2) 1/2" LB Conduit Bodies
- (2) 1/2" LR Conduit Bodies
- (6) Plastic threaded bushings
- (6) 4" x 7" Plastic storage bins
- 1/2" EMT bender
- Ugly's Conduit Bending Book
- CWT lab manual

## Wiring Training Systems

### **Commercial Wiring and Conduit Trainer (CWT200)**

*Includes all of the CWT100 components\* plus:*

- 125 amp, 6 space three phase panel  
*(Replaces 1—100 amp, 8 space single phase panel)*
- NEMA 3R enclosure 6" x 6"
- 24" NEMA wireway duct 4" x 4"
- (2) 1/2" EMT corner coupling
- (2) 4" x 4" metal boxes, two gang
- (2) 1/2' LL Conduit bodies
- 1/2" C Conduit body
- Double pole, 20 amp breaker
- (2) Single pole, 20 amp breakers
- Three pole, 20 amp breaker
- (2) Single pole, 15 amp breakers
- Single phase, 115/230 volt, 1/4 hp motor
- Three phase, 208-230/460 volt, 3/4 hp motor
- NEMA type 1, manual starter switch, double pole
- NEMA type 1, manual starter switch, three pole
- 4' fluorescent fixture with bulbs
- 120 volt, 1/2" threaded photocontrol
- (6) Plastic lampholders, keyless
- (4) 1/2" flexible conduit connectors, 90s, Polytuff
- (4) 1/2" flexible conduit connectors, straight, Polytuff
- (20) female nylon insulated terminals
- (20) fork nylon insulated terminals
- (10) 20 amp commercial receptacles
- (6) commercial grade single pole switches
- (3) Commercial grade three way switches
- (2) Commercial grade four way switches
- (2) 240 volt receptacles
- (2) 20 amp GFCI
- 24 hour electromechanical timer
- (50') 1/2" flexible conduit, Polytuff
- Single phase, 240V fusible safety switch 30A
- Three phase, 240V fusible safety switch 30A
- NEMA 20A twistlock plug, 2 pole, L6-20
- NEMA 20A twistlock plug, 3 pole, L21-20P

### **Commercial and Industrial Wiring Trainer (CWT300)**

*Includes all of the CWT200 components plus:*

- (15) Conduit mounting caddies
- (20) 1/2" universal pipe clamps with screws and nuts
- (9) Plastic threaded bushings
- Three phase 208-230/460 volt, 3/4 hp motor
- Plug cover lockout device
- Safety lockout padlock hasp
- Safety lockout tag
- Louvered bin
- (6) Plastic bins
- (25) Twister wire nuts
- (2) IEC three phase motor starters
- (3) IEC auxiliary blocks for three phase motor starter
- Three phase forward/reversing motor starter
- (2) Contact relays
- Multifunction time delay relay
- 11 pin relay base
- Emergency stop pushbutton
- (2) Start pushbuttons (green) NO
- (2) Stop pushbuttons (red) NC
- (2) Forward/reverse pushbuttons (yellow) NO/NC
- Two position selector switch, NO
- (3) LED indicator lights (red, yellow, and green)
- NEMA 1 electrical enclosure (24" x 20" x 8")
- 208-115V control transformer



## Wiring Training Systems

### Model 1800 Residential Wiring Package

The training package includes:

- 100 amp meter base with weather head, 15' of 14/4 SO cord, twist lock male and female plugs, and lockout/tagout
- 12 circuit breaker panel with 100 amp main breaker, and 2 single pole amp breakers
- (2) 2-gang switch boxes
- (2) 1-gang switch boxes
- (5) 1-gang duplex receptacle boxes
- Round box with bar for outdoor light
- (2) Round boxes with bar for inside lights
- (2) Round boxes with bar for smoke detector
- Bathroom vent fan
- Doorbell system with 2 buttons



### Add-on package (Model 1801)

- 250' 12/2 with a ground romex
- 250' 12/3 with a ground romex
- (2) Single pole switches
- (2) Three way switches
- Four way switch
- Single pole dimmer switch
- Three way dimmer switch
- (3) Duplex receptacles
- 220 VAC receptacle
- GFCI receptacle with weatherproof cover
- (2) Keyless light fixtures

- Outdoor lights
- (3) 60 watt outdoor bulbs
- (2) Smoke detectors
- Box red wire nuts
- Box yellow wire nuts

## Wiring Training Systems

### Model 7600 Automatic Transfer Switch (ATS) Generator Training System

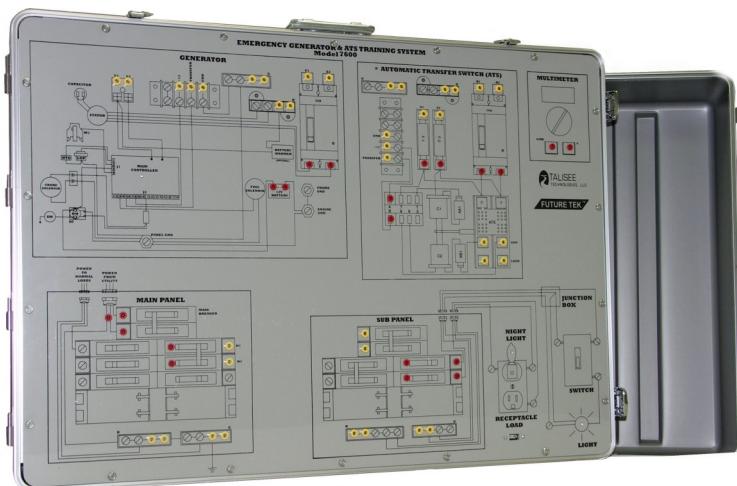

**Future Tek, Inc.'s Model 7600 Automatic Transfer Switch (ATS) Generator Training System** is an unique trainer using computer simulation to keep a student safe from electrical and mechanical dangers and also from the fumes of a real in house generator. The system shows a complete functionality of a generator transfer switch system. The trainer uses 240V, 120V, and low voltage for the backup generator system. Each component in the system can be checked using voltage measurements for proper operations and for troubleshooting. Each component, including the main panel, sub-feed panel for the back-up generator, the transfer switch, the generator, and the loads will be individually wired by the student. When the student has completed wiring, the instructor can do a test to check the wiring and if there is a mistake it will tell them the location of the wiring problem. After the wiring is completed correctly the instructor can go through a complete initial setup on the generator transfer switch training system.

An example is: The correct procedures in turning on breakers, generators, and transfer switch so that the proper procedure is installed so something does not come on that shouldn't. After the system has been correctly wired and completely energized you can go to each component; such as the main panel, sub panel, automatic transfer switch, or the generator; and take any voltage or resistance reading as necessary to show the student all proper voltage sources with the utility company having power on the system. Then, flip a switch on the computer simulated software and it simulates a downed line. Now the student can check all the measurements and how it should work in a proper back-up situation. When the generator actually comes on, the transfer switch is transferred, and all the loads are working off of the subpanel. Once the students have complete understanding of the operation, the wiring, and all of the voltage checks for proper operation; then the instructor can begin to insert faults into the trainer. Examples of the faults are a bad battery not starting the generator, the generator controls are bad, a bad fuse, or a bad breaker. All of these faults can be added by the instructor and monitored by the instructor. The student will need to use their computer to open up each individual panel and their voltmeter to take their own voltage readings on the trainer itself.



## **Model 2000-WS** Residential/Commercial/ Industrial Lighting Trainer

Future Tek Model 2000-WS Lighting Trainer includes many of the common Lighting Control devices encountered in Residential, Commercial and Industrial applications. As with all of our trainers, the Model 2000-WS comes with Lab Manuals and Power-Point presentations.

### **Model 2000-WS Training Package includes:**

- 1—Model 200 Single Pole Switch
- 1—Model 200A Single Pole Switch
- 2—Model 201 Three Way Switches
- 2—Model 201A Three Way Switches
- 1—Model 202 Four Way Switch
- 1—Model 202A Four Way Switch
- 1—Model 203 Rocker Switch
- 1—Model 204 Dimmer and Fan Control Switch
- 1—Model 205 PhotoContol or Photocell
- 1—Model 206 Motion Switch w/ Photocell
- 2—Model 207 Keyless Lamp Holder
- 1—Model 208 Fluorescent 2 Bulb Strip Light
- 1—Model 209 Exit Light
- 1—Model 210 Incandescent Wall Light
- 1—Model 211 LED Wall Light
- 1—Model 212 LED Emergency Light
- 1—Model 213 Security Light
- 1—Model 214 Tork Mechanical Timer
- 1—Model 215 Tork Programmable Timer
- 1—Model 216 Mechanical Contractor Panel
- 1—Model 217 Programmable Contractor Panel w/ Touchscreen
- 1—Model 218 High Pressure Sodium Security Light
- 8—Model 219 Open Slot Wire Duct
- 2—Model 220 Power/GFCI Module
- 1—Model 220A Power/GFCI Module
- 1—Model 221 Current Module
- 1—Extruded Aluminum Metal Cart



# Building tomorrow's landmarks



200



200A



201



201A

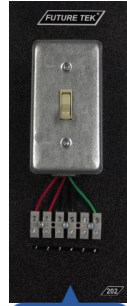

202



202A



203



204



205

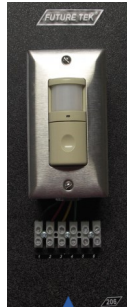

206

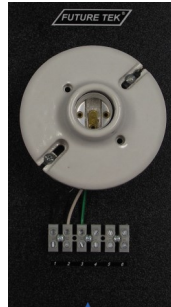

207



208



209



210



211

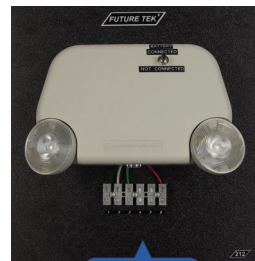

212



213



214



215



216



217



218



220



220A

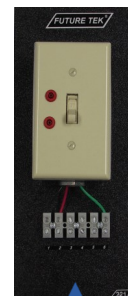

221



## Security and Fire Alarm Trainers

Future Tek provides Security/Fire Alarm Trainers for the home (Model 4000) and for Commercial and Industrial Applications (Model 4200)

### Model 4000 Home Security Workstation

The training package includes:

- Desktop Rack (Model 5100)
- Control panel with backup battery module (Model 400)
- LED keypad module (Model 401)
- Alphanumeric LCD keypad module (Model 402)
- Transformer and duplex receptacle module (Model 403)
- RJ31 block and cord module (Model 404)
- Pet-immune motion detector (PIR) module (Model 405)
- Door module (Model 406)
- Window module (Model 407)
- Horn module (Model 408)
- Smoke alarm module (Model 409)
- Glass break module (Model 410)
- 500' fire retardant cable
- 500' control cable

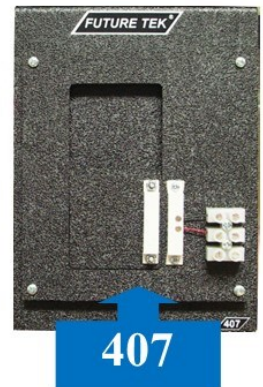
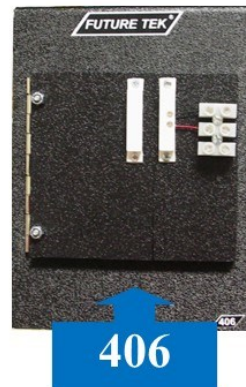
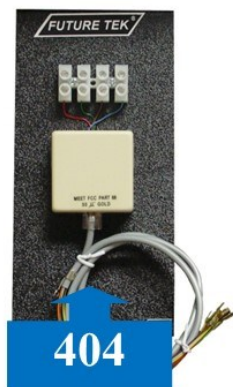
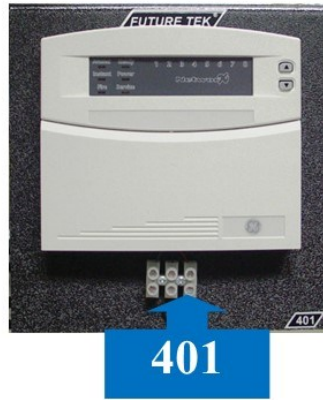



## Security and Fire Alarm Trainers

### Model 4200 Commercial/Industrial Fire Alarm Workstation

The training package includes:

- Desktop Rack (Model 5100)
- Eight zone control panel module with polling loop (Model 422)
- Main commercial alpha keypad module (Model 423)
- Paddle –Style liquid flow switch module (Model 424)
- Remote commercial alpha keypad module (Model 425)
- 12vdc/24vdc bell/siren module (burglary) (Model 426)
- Two wire smoke detector module (Model 427)
- Single action pull station module (Model 429)
- Addressable smoke detector module (Model 435)
- 12vdc/24vdc bell/siren module (fire) (Model 436)
- Control transformer (Model 441)
- Canned Smoke (Model 4213)
- 500' fire retardant cable
- 500' control cable



422



423



424



425

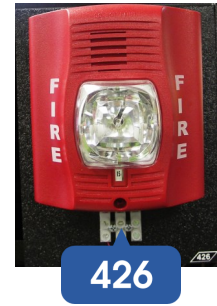

426



427



429



435



436



441

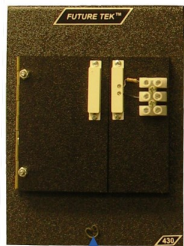

430

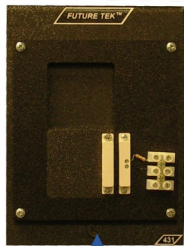

431

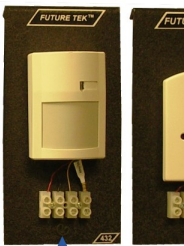

432



433



442



438



440

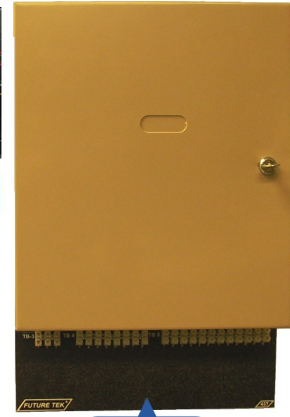

437

## Security and Fire Alarm Trainers

### Add-on Security Package (Model 4200-S)

- Door module (Model 430)
- Window module (Model 431)
- Pet-immune motion detector (PIR) module (Model 432)
- Glass break module (Model 433)

### Optional Equipment

- Heavy duty roll around cart (Model 5102)

### Add-on Access Control Package (Model 4200-V)

- Vista key module (Model 437)
- Door termination module (Model 438)
- Proximity card reader module (Model 440)
- V-plex extender module (Model 442)
- 25 Proxcards

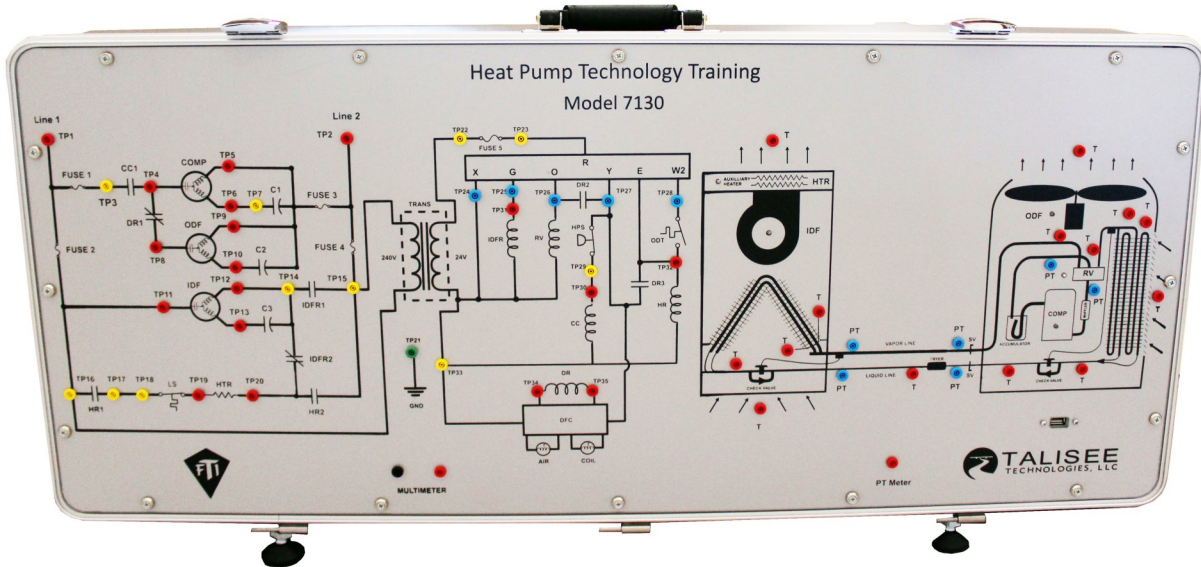

## HVAC Trainers

### Model 7130 Heat Pump Technology Trainer

Future Tek's Heat Pump Technology Training System connects via USB to your computer and includes our troubleshooting software. The software emulates each circuit and allows timed, interactive troubleshooting. Fault selection may be made by the instructor or randomly with the software provided.

**Detailed student reports provide documentation required for accreditation.**

In solving the inserted faults, the student takes readings with the leads provided. Once the problem is located, corrective action is taken and the system is retested to confirm recovery. Each measurement and corrective action is automatically recorded. A detailed student report may be generated, specific for each student, detailing by fault: the time utilized, the number of voltage and resistance measurements performed, the number of components replaced, and if the fault was corrected.

## Model 7130 Heat Pump Technology Trainer

**System Control**  
TALISEE TECHNOLOGIES, L.L.C.  
Heat Pump System Overview  
10/25/2019 9:42:37 AM

Technician On Call: No Name Was Entered  
Complaint: Insufficient Heating  
Fault Type: Electrical and Mechanical Faults  
History: None  
Fault #: ???  
Problem #: 1

**Mechanical Data**  
MODE: OFF  
SATURATION TEMPERATURE: 41  
INDOOR AIR FLOW (cfm):  
OUTDOOR AIR FLOW (cfm):  
CAPACITY (BTU/h):  
DEFROST: OFF

**ELECTRICAL STATUS**  
POWER: ON  
INDOOR FAN: OFF  
OUTDOOR FAN: OFF  
COMPRESSOR: OFF  
HEATER COIL: OFF

Elapsed Time (min): 01  
Time Limit (min): 20

**MEASUREMENTS**  
VOLTAGE: 0  
PRESSURE:  
TEMPERATURE:

**AMBIENT CONDITIONS**  
OUTDOOR TEMPERATURE: 43.3  
INDOOR TEMPERATURE: 60

**OPTIONS**  
View Mechanical System  
View Low Voltage Circuit  
View High Voltage Circuit  
System Operating Properly  
About This problem  
Quit Session

Thermostat: 70

Power: ON

System Overview

**Detail Report**  
11/14/2018  
No Name Was Entered  
Detailed Report  
Student ID: No ID Entered  
Session Type: Troubleshoot

Fault Description	Volt meas	P/T Meas	time	comp	rep.	connect	comment
(32) - Contact IDFR1 Open	1	1	1.3	2	yes		Excellent work
(32) - Contact IDFR1 Open	0	0	1.1	4	yes		should review system operation
(1) - Fuse 1 Blown	0	0	.7	2	yes		Excellent work
(27) - None	0	0	.2	0	yes		Excellent work
(6) - CC Coil Open	0	0	.3	0	yes		Excellent work
(97) - Contact IDFR1 Open	0	0	.5	0	yes		Excellent work
(2) - Fuse 2 Blown	0	0	.2	0	yes		Excellent work
(90) - Transformer Primary Open	0	0	.	0	no		

Detailed Report

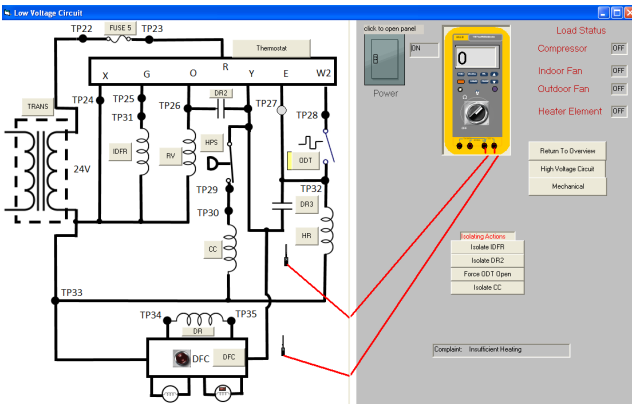

Low Voltage Electrical System

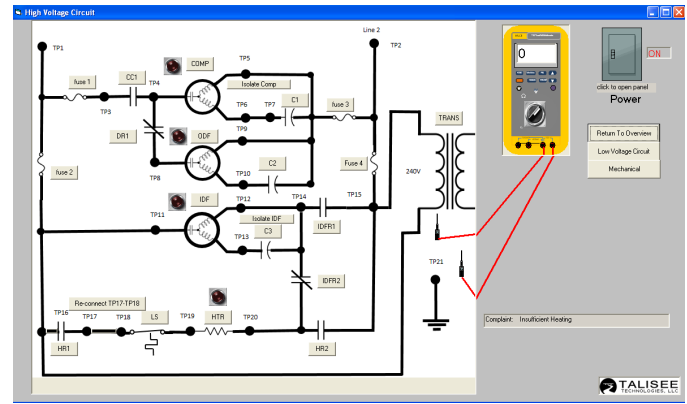

High Voltage Electrical System

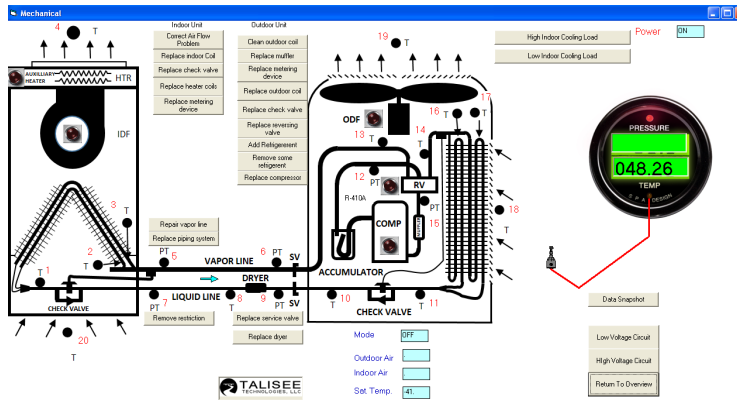

Mechanical System

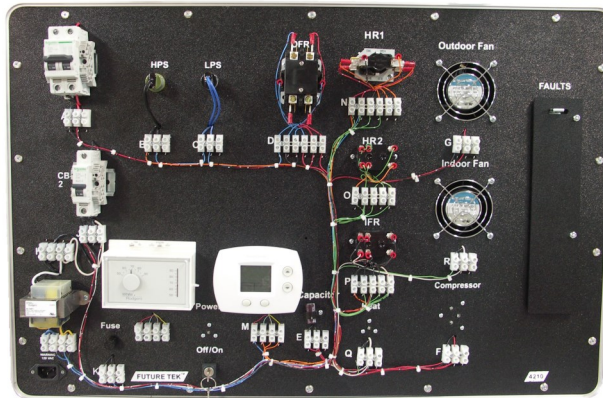

## HVAC Training Systems

### Electrical Troubleshooting Trainer (Model 4210)

Model 4210 includes “Real World” components mounted on our non-conductive black textured board in a sturdy case with removable cover. Designed as an interactive troubleshooting trainer where the faults may be turned on or off by the instructor.

- 120 VAC male receptacle 3-wire 6’ cord
- 240 VAC source voltage breaker
- 120 VAC source voltage breaker
- 240 VAC high pressure switch
- 240 VAC low pressure switch
- 24 VAC outdoor fan relay
- Capacitor
- Simulated compressor
- 240 VAC outdoor fan
- 120 VAC/24 VAC transformer
- Transformer secondary fuse
- Mechanical thermostat
- Digital thermostat
- (2) 24 VAC heating relays
- 24 VAC indoor fan relay
- Simulated heat
- 120 VAC indoor fan
- Keyed on/off lock-out switch

#### Model 4210 Available Faults:

- No outdoor source voltage
- Low pressure switch open
- Outdoor fan bad
- Blown secondary fuse
- Heating relay-2 coil bad
- Indoor fan relay coil bad
- Normally open indoor fan
- No indoor source voltage
- Outdoor fan relay coil bad
- No secondary voltage
- Heating relay-1 coil bad
- Heating relay-2 normally open
- High pressure switch open
- Normally open outdoor fan contact not closing
- Heating relay-1 normally open contact not closing
- Indoor fan bad



# Manufacturing

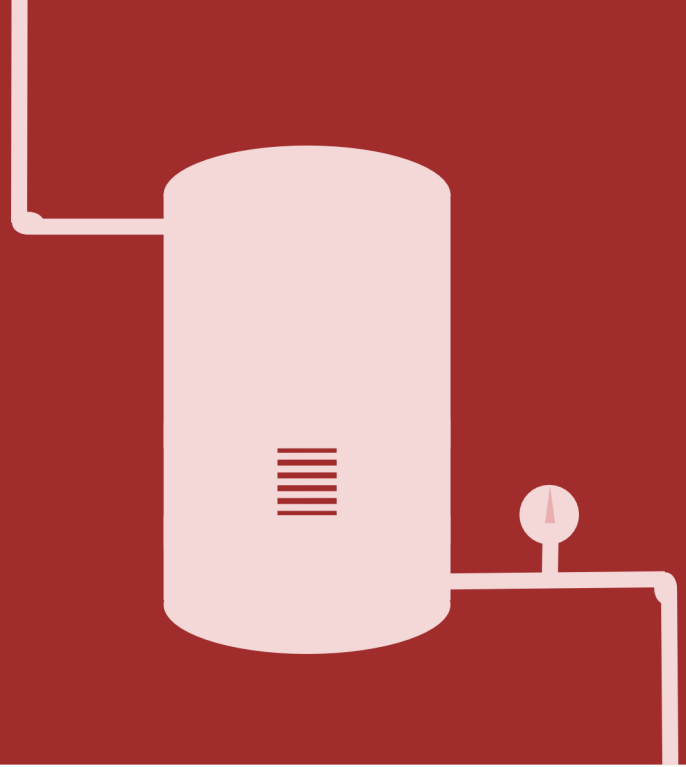

Skilled Manufacturing Technicians are always in demand. With this in mind, Future Tek has designed training systems which provide hands-on, real-world skills development.

Our manufacturing sector training systems include:

- Motor Controls Training Systems
- Programmable Logic Controllers (PLC) and Relay Ladder Logic Training Systems
- Mechanical Training Systems
- Transformer Trainer
- Pneumatic and Hydraulic Training Systems
- Process Technology Training Systems

## Motor Control

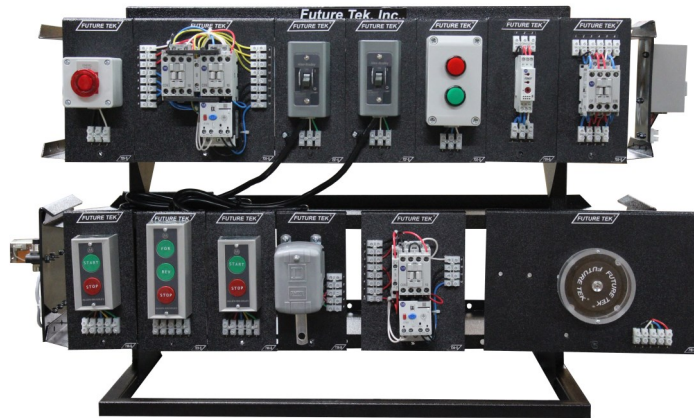

### Model 7000-S (Single-phase)

- Desktop Rack (Model 5100)
- (2) Start/Stop Pushbutton Modules (Model 700-S)
- Forward/Reverse/Stop Pushbutton Module (Model 701-S)
- Indicator Light Module (Red/Green) (Model 702-S)
- (2) Single-phase Motor Starter Modules (Model 704-S)
- Single-phase reversing motor starter module (Model 705-S)
- (2) Source Voltage with Heater Modules (Model 707-S)
- Control Relay Module (Model 708-S)
- 3-Position Selector Switch (Hand/Off/Auto) (Model 712-S)
- (2) Single-phase AC Reversing Motor Modules (Model 716-S)
- Inductive Proximity Switch Module (Model 725-S)
- (2) E-Stop Station Module (Model 729-S)
- Float Switch Module (Model 730-S)
- Photo Switch Module (Model 733-S)
- Time On/Off Delay Module (Model 739-S)

### Optional Add-ons:

- Micro 850 PLC no Analog (Model 746-S)
- Motor Control Fault Module (Model 1301)
- Desktop Rack with 2 Sliding Shelves (Model 5100-S)
- Mobile Cart (Model 5102)
- Three-phase Add-on Package:
  - \*Three-phase Motor Module (Model 716)
  - \*AC Variable Speed Motor Drive (Model 718)
  - \*AC Drive Control Panel (Model 719)



700-S



701-S

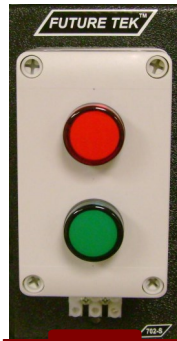

702-S

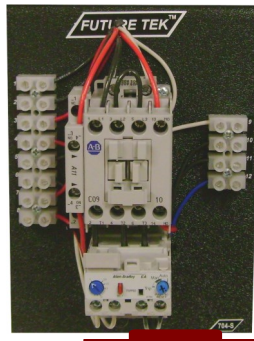

704-S

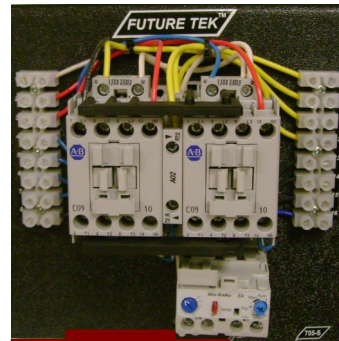

705-S



707-S

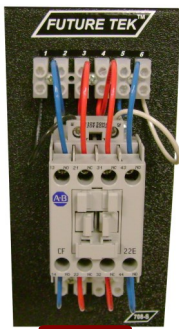

708-S



712-S



716-S

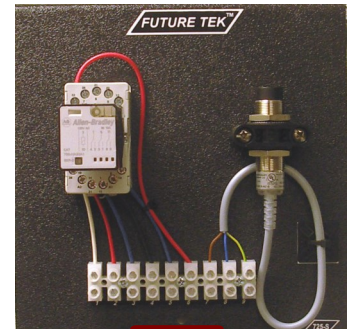

725-S



729-S



730-S

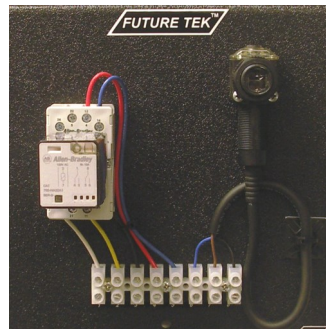

733-S

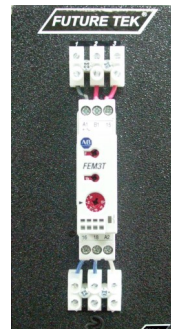

739-S

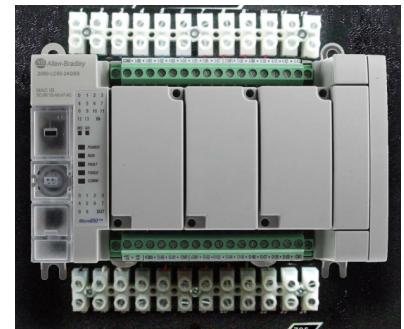

785-S



## Motor Control

### Model 7000 (Three-phase)

- Desktop Rack (Model 5100)
- Start/Stop Pushbutton with Jumper Module (Model 700)
- Start/Stop Pushbutton Module (Model 700-A)
- Forward/Reverse/Stop Pushbutton Module (Model 701)
- (2) Indicator Light Modules (Red/Green) (Model 702)
- Indicator Light Modules (Red/Amber/Green) (Model 703)
- (2) Three-phase Motor Starter Modules (Model 704)
- Three-phase reversing motor starter module (Model 705)
- (2) Industrial Finger Safe Control Transformers (Model 706)
- Three-phase breaker Module with Lockout (Model 707)
- Control Relay Module (Model 708)
- Limit Switch Module (Model 711)
- 3-Position Selector Switch (Hand/Off/Auto) (Model 712)
- Manual Motor Starter Module (Model 713)
- (2) Three-phase Disconnect with Lockout Modules (Model 715)
- (2) Three-phase AC Motor Modules (Model 716)
- On/Off Photo Switch Module (Model 722)
- (2) E-Stop Station Module (Model 729)
- Time On/Off Delay Module (Model 739)

### Optional Add-ons:

- Desktop Rack with 2 Sliding Shelves (Model 5100-S)
- Mobile Cart Model 5102
- Float Switch (Model 730)
- Latching Relay (Model 731)
- Tork Timer (Model 734)
- Horn Module (Model 735)
- Micrologix 1400 PLC (Model 745)



### Model 7001 (Three-phase Advanced Add-ons Package)

- DC Motor Module (Model 717)
- AC Variable Speed Motor Drive Module (Model 718)
- AC Drive Control Panel (Model 719)
- DC Variable Speed Motor Drive Module (Model 720)
- One-shot Time On/Off Delay Photo Switch Module (Model 724)
- Capacitive Proximity Switch Module (Model 726)



700



700A



701

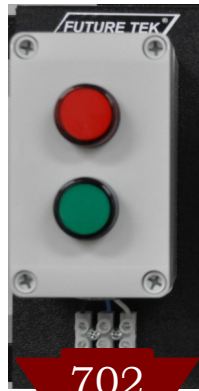

702



703

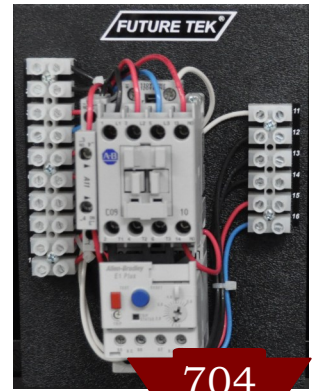

704

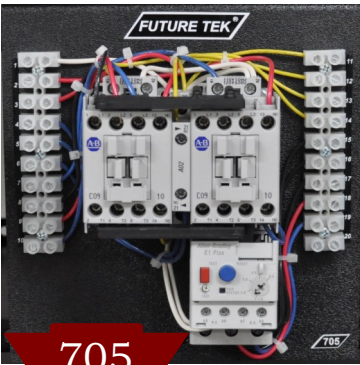

705

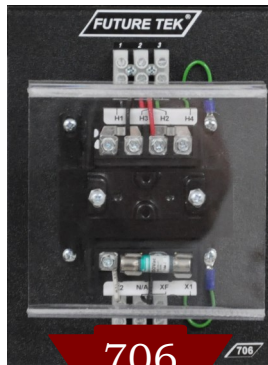

706



707

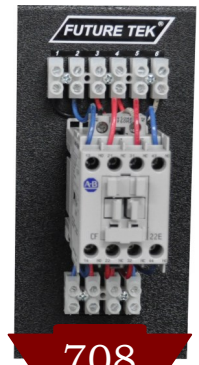

708



711



712



713



715



716



717



718

call 888-299-0864 for a quote or more info



719



720



722

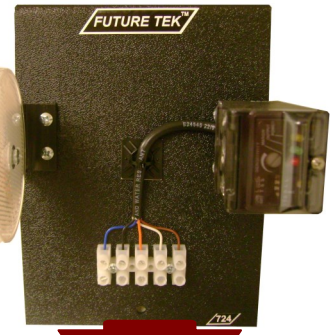

724

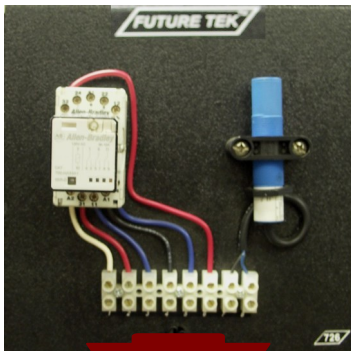

726



729

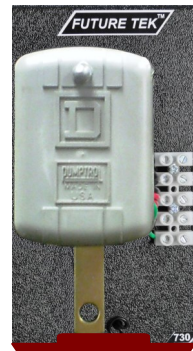

730

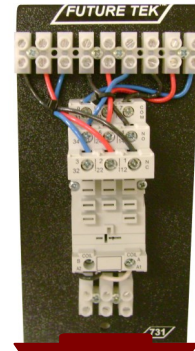

731



734



739

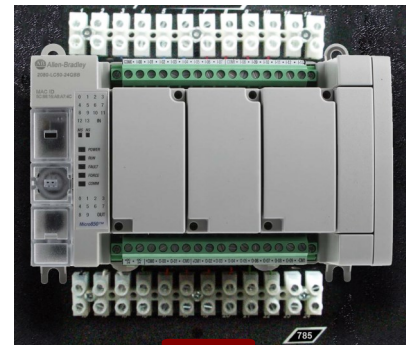

785

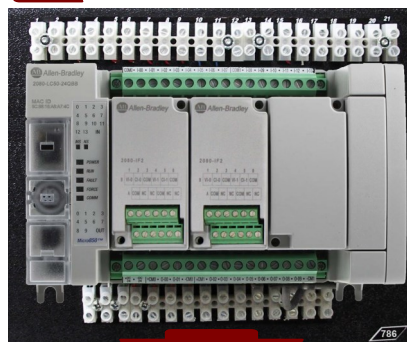

786



## Motor Control Troubleshooting Package



### Model 7000 –TS Basic Three-Phase Motor Control Training System with Troubleshooting Capabilities

- Desktop Rack (Model 5100)
- Start/Stop Pushbutton with Jumper Module with Troubleshooting (Model 700-F)
- Start/Stop Pushbutton Module (Model 700-A)
- Forward/Reverse/Stop Pushbutton Module with Troubleshooting (Model 701-F)
- (2) Indicator Light Modules (Red/Green) (Model 702)
- Indicator Light Modules (Red/Amber/Green) with Troubleshooting (Model 703-F)
- Three-phase Motor Starter Module with Troubleshooting (Model 704-F1)
- Three-Phase Motor Starter Module with Troubleshooting (Model 704-F2)
- Three-phase reversing motor starter module with Troubleshooting Model 705-F)
- Industrial Finger Safe Control Transformer Module (Model 706)
- Industrial Finger Safe Control Transformer Module with Troubleshooting (Model 706-F)
- Three-phase breaker Module with Lockout (Model 707)
- Control Relay Module (Model 708)
- Limit Switch Module (Model 711)
- 3-Position Selector Switch (Hand/Off/Auto) (Model 712)
- Manual Motor Starter Module (Model 713)
- (2) Three-phase Disconnect with Lockout Modules (Model 715)
- Three-phase AC Motor Module with Troubleshooting (Model 716-F1)
- Three-Phase AC Motor Module with Troubleshooting (Model 716-F2)
- On/Off Photo Switch Module (Model 722)
- E-Stop Station Module (Model 729)
- Time On/Off Delay Module (Model 739)
- Master Fault Controller with Communications Module (7000-Master)



## Advanced Three-Phase Motor Control Training Package with Troubleshooting

- Desktop Rack (Model 5100)
- Start/Stop Pushbutton with Jumper Module (Model 700)
- Start/Stop Pushbutton with Jumper Module with Troubleshooting (Model 700-F)
- Start/Stop Pushbutton Module with Troubleshooting (Model 700-A-F)
- Forward/Reverse/Stop Pushbutton Module with Troubleshooting (Model 701-F)
- Indicator Light Module (Red/Green) (Model 702)
- Indicator Light Module (Red/Green) with Troubleshooting (Model 702-F)
- Indicator Light Modules (Red/Amber/Green) with Troubleshooting (Model 703-F)
- Three-phase Motor Starter Module with Troubleshooting (Model 704-F1)
- Three-Phase Motor Starter Module with Troubleshooting (Model 704-F2)
- Three-phase reversing motor starter module with Troubleshooting Model 705-F)
- Industrial Finger Safe Control Transformer Module (Model 706)
- Industrial Finger Safe Control Transformer Module with Troubleshooting (Model 706-F)
- Three-phase breaker Module with Lockout (Model 707)
- Control Relay Module with Troubleshooting (Model 708-F)
- Limit Switch Module with Troubleshooting (Model 711-F)
- 3-Position Selector Switch (Hand/Off/Auto) with Troubleshooting (Model 712-F)
- Manual Motor Starter Module (Model 713)
- Three-phase Disconnect with Lockout Module (Model 715)
- Three-phase Disconnect with Lockout Module with Troubleshooting (Model 715-F)
- Three-phase AC Motor Module with Troubleshooting (Model 716-F1)
- Three-Phase AC Motor Module with Troubleshooting (Model 716-F2)
- On/Off Photo Switch Module with Troubleshooting (Model 722-F)
- Inductive Proximity Switch Module with Troubleshooting (Model 725-F)
- (2) E-Stop Station Module (Model 729)
- Time On/Off Delay Module with Troubleshooting (Model 739-F)
- Master Fault Controller with Communications Module (7000-Master)

### Optional Add-ons:

- Desktop Rack with 2 Sliding Shelves Model 5100-S
- Mobile Cart Model 5102
- MicroLogix 1400 PLC with Analog (Model 728)
- Float Switch Module (Model 730)
- Latching Relay Module (Model 731)
- Tork Timer Module (Model 734)
- Horn Module (Model 735)
- Micro 850 PLC no Analog (Model 785)
- Motor Control Fault Module (Model 1301)





Front View



Back View

## **MODEL MCT300 (Motor Control Trainer)**

The Model MCT300 provides students with the opportunity to practice with multiple motors, starters, pushbuttons, timers, and simulate a number of industry motor control scenarios. An AC drive is also featured for students to develop motor speed control and motor braking skills. This model is designed to allow motor control students to experiment with small horsepower manual motor starters, single magnetic motor starters, multiple motor starter installation, forward/reversing motors, multiple control station wiring, and time delay controls. The trainer also provides training with limit and proximity switching as well as polarized reflective photoelectric controls. This unit features (2) three phase motors, a control cabinet that contains starters, timers, and indicator lights, and an individual control station cabinet which contains control pushbuttons, switches, and other components. This trainer simulates a situation in which the starters and timers are located at one location while the pushbuttons that control the motors are located at a different location. The greatest advantage to this trainer is its versatility in offering a wide variety of learning experiences. The instructor or student can develop many different motor control scenarios that meet the demands of needed training experiments.

The student guide includes a set of 15 project schematics that guide the student through several different motor control scenarios. Each of the projects require between 1 1/2 to 2 hours to complete for a total of over 30 hours of hands-on training. However, this trainer is not limited to just the 15 projects provided in the student guide, Model MCT300 provides unlimited flexibility in hands-on lab assignments and offers the student or instructor the ability to customize many additional lab experiences to meet your training demands.



Control Panel Interior

**SPECIFICATIONS**

**Height:** 68"  
**Width (Base):** 32"  
**Length:** 48"



Lockout Station

**MODEL MCT300 (Motor Control Trainer)**

*Includes all of the following components:*

- (2) 1/3 HP, 208-220/440 Volt Three Phase Motor
- (1) 115V-230V 1HP AC Drive
- (1) 2 Unit Stack Light with Base and Extension
- (1) AC Proximity Switch
- (1) Reflective Photo Sensor with Reflector
- (1) 150V, Control Transformer
- (4) IEC Three Phase Motor Starters
- (4) IEC Auxiliary Blocks for Starters
- (3) IEC Overloads for Starters
- (1) Rev Kit Line Side
- (1) Rev Kit Load Side
- (2) Limit Switches
- (2) Contact Relays
- (2) 11 Pin Contact Relay Bases
- (1) Multifunctional Time Delay Relay
- (1) 11 Pin Time Delay Relay Base
- (2) Stop Pushbuttons, Red, NC
- (2) Start Pushbuttons, Green, NO
- (1) Emergency Stop Pushbutton, NC
- (2) Forward/Reverse Pushbuttons, Yellow, NO/NC
- (1) Two Position Selector Switch, NO
- (2) LED, Indicator Light, Red
- (2) LED, Indicator Light, Green
- (3) NEMA 1, Electrical Enclosures, various sizes
- (1) 1-Pole Safety Fuse Holder, DIN Mount
- (1) 3-Pole Safety Fuse Holder, DIN Mount
- (1) 25' Fish Tape
- (1) 10ft 12/5 SJ Cord
- (1) NEMA, 20AMP, 250V, 4-Wire Twist Lock Plug
- (3) 15 AMP, Fuses for Safety Switches, NON
- (1) Three Phase, 240V Safety Switch, 30A
- (1) Plug Cover Lockout Device
- (1) Steel Body Safety Lockout Padlock
- (1) Safety Lockout Tag
- (1) 6" Electrical Screwdriver
- (1) 150 Piece Terminal Kit
- (1) Set of Instructor and Student Manuals



## Motor Control Troubleshooting Training System

### Model 7100 Motor Control Troubleshooting Training System

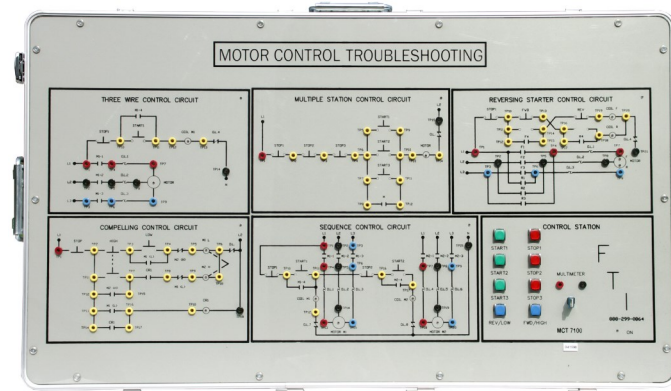

This motor control troubleshooting training system connects via USB to your computer and includes our Troubleshooting Software. The computer emulates each circuit and allows timed, interactive troubleshooting.

This trainer is based on a computer model of the five (5) most common industrial motor control circuits. Each circuit has test points to check voltage and resistance. The LEDs on each circuit will illuminate indicating which particular device is energized. There are eight (8) pushbutton switches located on the Model 7100 panel. These serve as the control switches for each circuit.

The troubleshooting training system includes 152 faults that can be controlled by the instructor. The instructor may choose the faults to use or choose a selection of random faults. In the Random mode, the software will randomly select the faults until the time runs out. If the Fault Table is selected, the Fault Selection Table appears for all circuits. The instructor may select up to 25 faults in each circuit or 25 faults in all circuits. Just a few of the faults included are Three Wire Control Circuit, Multiple Station Control Circuit, Reversing Starter Control Circuit, Compelling Control Circuit, Sequence Control Circuit, and Control Station. The 152 faults are as real as it gets. For example, if the coil M1 is shorted it will take out the control voltage. If the student just resets the breaker without changing out the bad coil, it will trip the breaker again. The student must ohm out the M1 coil to see if it is bad, and then replace it. After the student has fixed all problems, he/she will check to see if the circuit is working properly, then go on to the next fault.

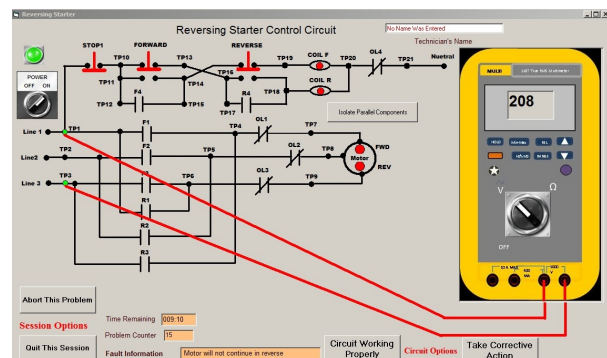
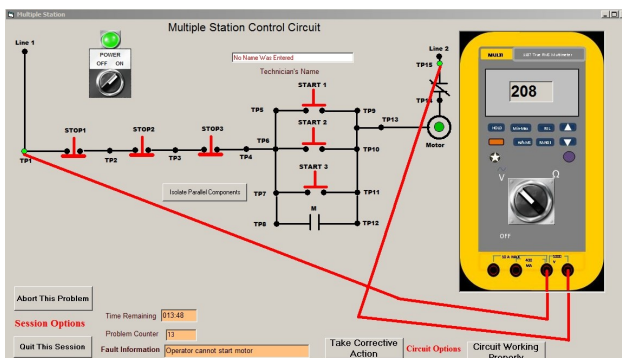





## Motor Control

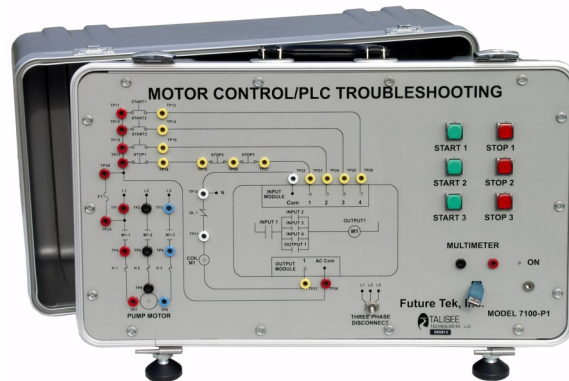

### Model 7100-P1 Motor Control/PLC Troubleshooting Trainer

This troubleshooting training system connects via USB to your computer and includes our Troubleshooting Software. The computer emulates a circuit and allows timed, interactive troubleshooting. This training system provides training and documentation for Motor Controls Troubleshooting and includes troubleshooting at the ladder logic level (PLC).

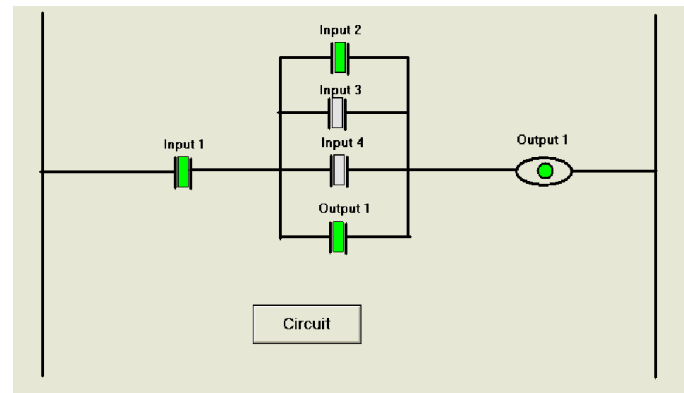
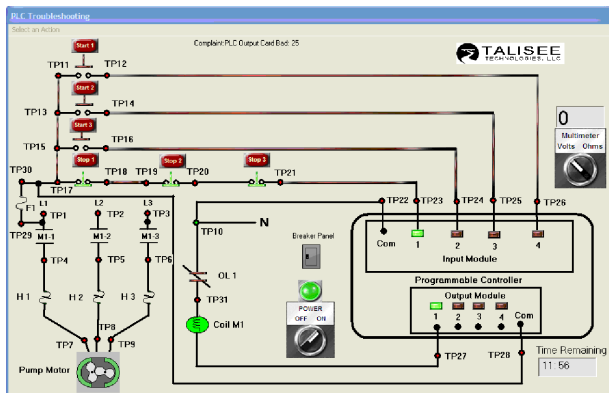

The Model 7100-P1 Motor Control/PLC Troubleshooting Trainer allows Circuit Correction plus Fault Resolution at the Ladder Logic level. This training system includes 51 faults that can be controlled by the instructor. The instructor may choose the faults to use or choose a selection of random faults. In the Random mode, the software will randomly select the faults until the time runs out. If the Fault Table is selected, the Fault Selection Table appears for the circuit.

This versatile trainer meets secondary, post-secondary, and industrial curriculum requirements. Students and instructors love the challenges that this trainer offers. The Model 7100-P1 challenges the students by keeping them motivated and interested in learning. It can be applied to introductory or advanced motor control circuits and three-phase power circuits. It is used in industry to test new employees in the electrical field, and update existing technicians.

The Model 7100-P1 is powered by the computer's USB port only.

## Programmable Logic Controllers (PLC)

Future Tek offers a large number of Allen-Bradley and Siemens PLC Training Systems designed to be utilized with peripheral equipment. All systems include name brand Programmable Logic Controllers (PLCs) along with Input and Output jacks for easy connection to external components, non-conductive, black, textured panel mounting and Lab Manuals filled with Hands-On, Real-World training exercises.

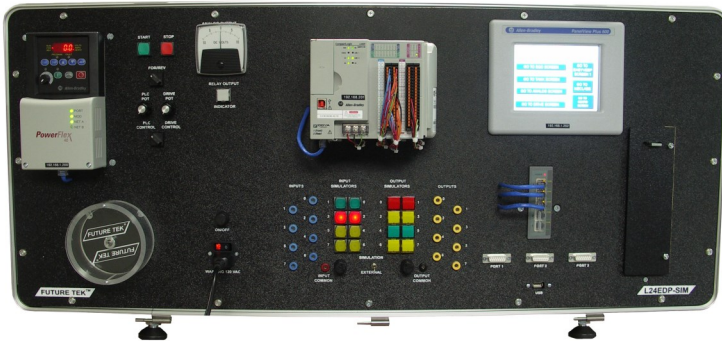

**L24-EDP-SIM**

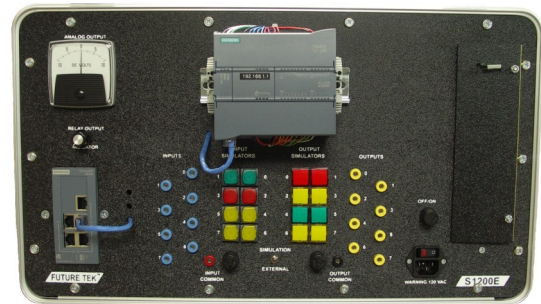

**S1200E**

## Programmable Logic Controllers (PLC)

### Standard Equipment:

- Input and Output Banana Jacks to connect with Real World Devices
- Mounted on a non-conductive black textured panel for safety

### Optional Equipment:

- Processor Module (Allen-Bradley and Siemens options)
- Motor/Drive Combinations (three phase motor and Allen Bradley PF40 and Siemens G120 variable speed drive options)
- HMI (human machine interface) (Allen-Bradley and Siemens options)
- Network Capabilities (DH485, EtherNet, ProfiNet, and/or DeviceNet)
- Suitcase mount (heavy-duty with removable front cover)
- Input and Output simulations (8 input and 8 output pushbuttons used for simulation)
- VoltMeter

*On the following pages is a summary of the Model configurations that we offer.*



## Programmable Logic Controllers (PLC)

### Siemens Simatic Step 7 1200 Series PLC Training Systems:

Model	PLC	Motor/Drive	HMI	Networking	Suitcase	Add-ons/Capabilities
<b>S1200-E</b>	Siemens 1200 Series	No	No	EtherNet	Yes	Simulators, Analog
<b>S1200-E-SIM</b>	Siemens 1200 Series	No	No	EtherNet	Yes	Simulators, Analog, Mechatronics Connections, Festo® EasyPort Interface
<b>S1200-ED</b>	Siemens 1200 Series	Yes	No	EtherNet	Yes	Simulators, Analog
<b>S1200-ED-SIM</b>	Siemens 1200 Series	Yes	No	EtherNet	Yes	Simulators, Analog, Mechatronics Connections, Festo® EasyPort Interface
<b>S1200-EDP</b>	Siemens 1200 Series	Yes	Yes	EtherNet	Yes	Simulators, Analog
<b>S1200-EDP-SIM</b>	Siemens 1200 Series	Yes	Yes	EtherNet	Yes	Simulators, Analog, Mechatronics Connections, Festo® EasyPort Interface
<b>S1200-EP</b>	Siemens 1200 Series	No	Yes	EtherNet	Yes	Simulators, Analog
<b>S1200-EP-SIM</b>	Siemens 1200 Series	No	Yes	EtherNet	Yes	Simulators, Analog, Mechatronics Connections, Festo® EasyPort Interface

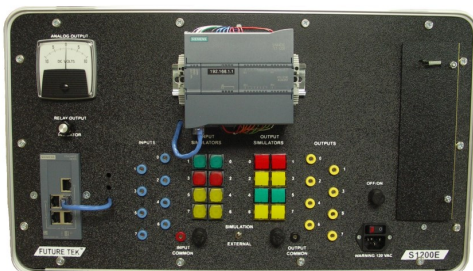

**S1200E**



**S1200-EP-SIM**

## Programmable Logic Controllers (PLC)

### Allen-Bradley RSLogix 500 Training Systems:

Model	PLC	Motor/Drive	HMI	Networking	Suitcase	Add-ons/Capabilities
<b>850-ABS</b>	Micro 850	No	No	EtherNet	Yes	Simulators
<b>850-ABS-SIM</b>	Micro 850	No	No	EtherNet	Yes	Simulators, Mechatronics Connections, Festo® EasyPort Interface
<b>850-I</b>	Micro 850	No	No	EtherNet	No	Simulators
<b>850-SA</b>	Micro 850	No	No	EtherNet	No	Simulators, Analog
<b>850-SAS</b>	Micro 850	No	No	EtherNet	Yes	Simulators, Analog
<b>850-SS</b>	Micro 850	No	No	EtherNet	Yes	Simulators
<b>850-SS-SIM</b>	Micro 850	No	No	EtherNet	Yes	Simulators, Mechatronics Connections, Festo® EasyPort Interface
<b>850-ED</b>	Micro 850	Yes	No	EtherNet	Yes	Simulators, Analog
<b>850-EP</b>	Micro 850	No	Yes	EtherNet	Yes	Simulators, Analog
<b>850-EDP</b>	Micro 850	Yes	Yes	EtherNet	Yes	Simulators, Analog
<b>1400-S</b>	Micrologix 1400	No	No	EtherNet	No	Simulators
<b>1400-SS</b>	Micrologix 1400	No	No	EtherNet	Yes	Simulators
<b>1400-SS-SIM</b>	Micrologix 1400	No	No	EtherNet	Yes	Simulators, Mechatronics Connections, Festo® EasyPort Interface





## 850-SS-SIM

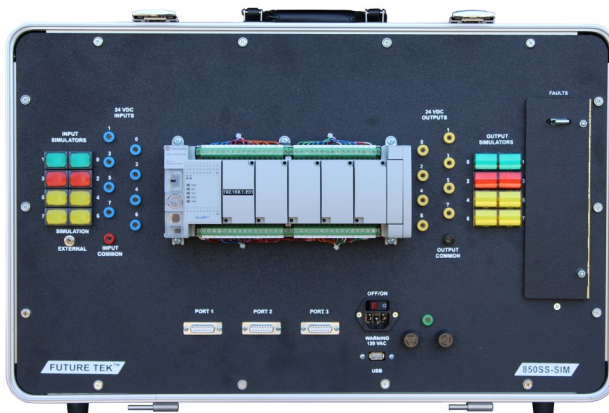

## 850-EDP-SIM



## 1400-SS



## 1400-SS-SIM



## Programmable Logic Controllers (PLC)

### Allen-Bradley RSLogix 5000 Training Systems:

Model	PLC	Motor/Drive	PanelView	Networking	Suitcase	Add-ons/Capabilities
<b>L24-E</b>	CompactLogix L24	No	No	EtherNet	Yes	Simulators, Analog
<b>L24-E-SIM</b>	CompactLogix L24	No	No	EtherNet	Yes	Simulators, Analog, Mechatronics Connections, Festo® EasyPort Interface
<b>L24-ED</b>	CompactLogix L24	Yes	No	EtherNet	Yes	Simulators, Analog
<b>L24-ED-SIM</b>	CompactLogix L24	Yes	No	EtherNet	Yes	Simulators, Analog, Mechatronics Connections, Festo® EasyPort Interface
<b>L24-EDP</b>	CompactLogix L24	Yes	Yes	EtherNet	Yes	Simulators, Analog
<b>L24-EDP-SIM</b>	CompactLogix L24	Yes	Yes	EtherNet	Yes	Simulators, Analog, Mechatronics Connections, Festo® EasyPort Interface
<b>L24-EP</b>	CompactLogix L24	No	Yes	EtherNet	Yes	Simulators, Analog
<b>L24-EP-SIM</b>	CompactLogix L24	No	Yes	EtherNet	Yes	Simulators, Analog, Mechatronics Connections, Festo® EasyPort Interface



## L24-SAS



## L24-EDP-SIM

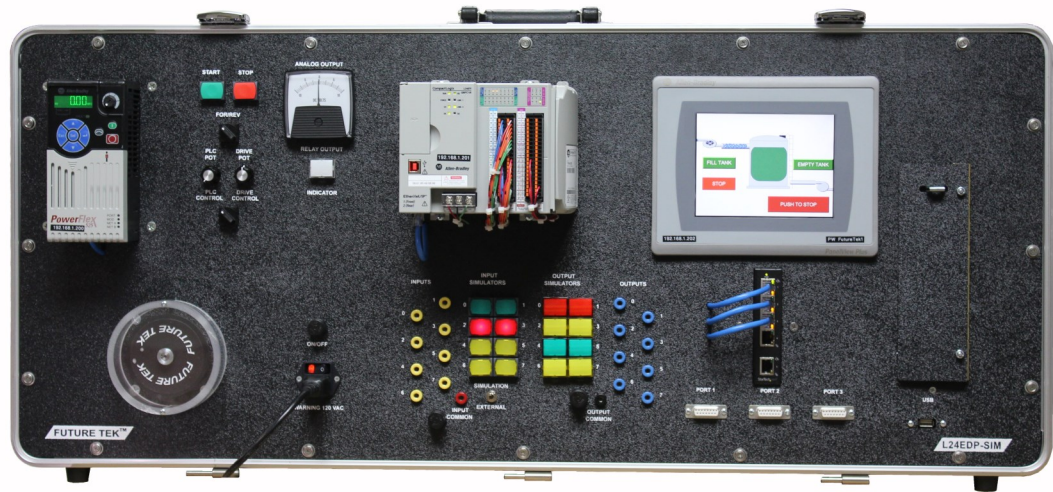

## L24-EP-SIM

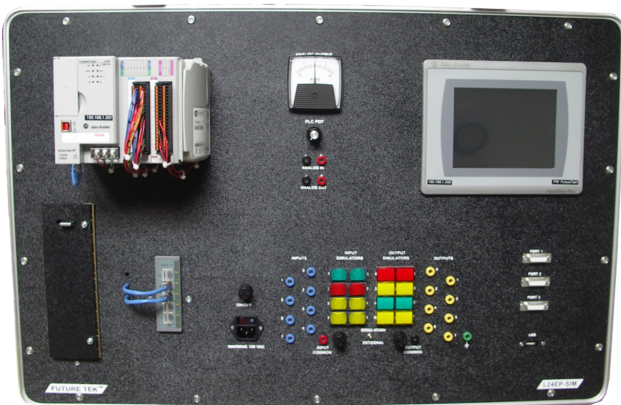

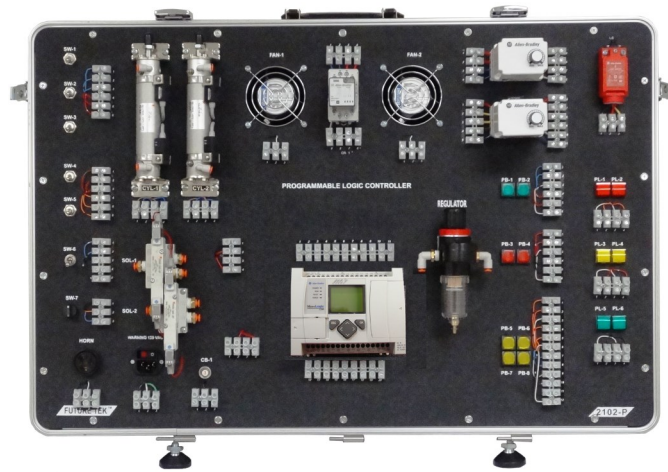

## Relay Ladder Logic

### 2100 Series

This series of training systems includes the following components to teach basic ladder logic functions in action.

#### The Basic System (Model 2101)

#### More advanced Models include PLCs

- 3 Amp resettable breaker
- (3) SPST toggle switches
- (2) SPDT toggle switches
- DPDT toggle switch
- Three-position selector switch
- (2) Lighted green momentary pushbuttons
- (2) Lighted Red Momentary Pushbuttons
- (4) Lighted amber momentary pushbuttons
- (2) Green indicator lights
- (2) Red indicator lights
- (2) Amber indicator lights
- Limit switch (1 NO & 1 NC contact)
- (4) 120 VAC solenoid valves
- Pulsating warning device with volume control
- Control relay (2 NO & 2 NC contacts)
- Time delay on relay (2 NO & 2 NC contacts)
- (2) 3 1/2" fans with guards
- Model 2102 includes AB Micro 850 PLC
- Model 2102-P includes pneumatic components with AB Micro 850 PLC
- Model 2103 with AB Micrologix 1400 PLC
- Model 2103-P-SIM includes pneumatic components with AB Micrologix 1400 PLC and Mechatronics Connections
- Model 2106 includes AB CompactLogix L24 PLC



## PF-525

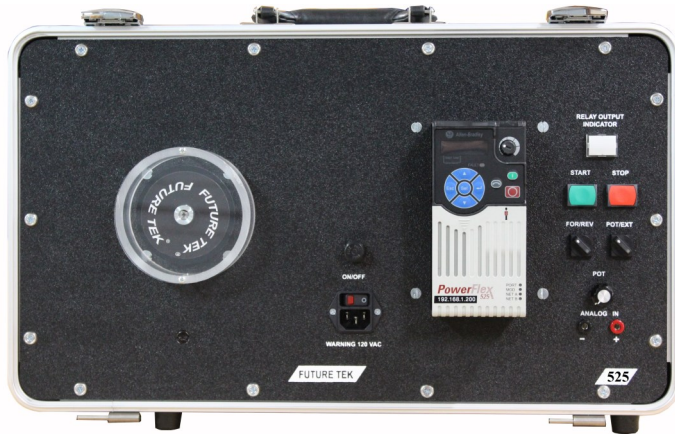

## 1247-ES

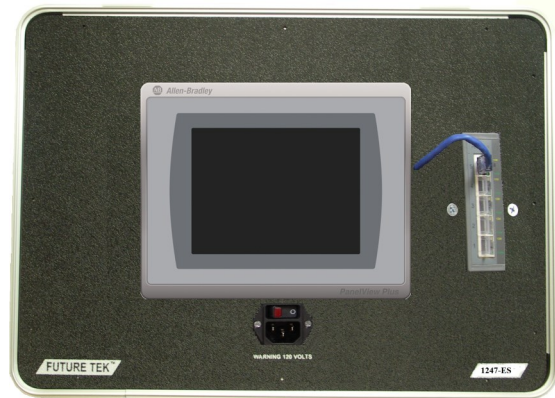

## Drive and PanelView Trainers

Future Tek offers motor drive and PanelView trainers which may be used with our PLC trainers or with any PLC

### Drive Trainers are:

- Model PF-525: AC variable speed motor drive for rack or desktop use. (motor not included)
- Model 525: AC variable speed motor drive and 1/3 horsepower three phase motor mounted in a suitcase.
- Model S163-E: AC variable speed motor drive, 1/3 horsepower three-phase motor, and an EtherNet Hub mounted in a suitcase.

### PanelView Trainers are:

- Model 1247-E: Touch PanelView Trainer with EtherNet
- Model 1247-ES: Suitcase touch 700 PanelView PlusTrainer with EtherNet
- Model 800-EP: Suitcase touch 800 PanelView Trainer with EtherNet

## Conveyor Trainers

### Model 6000

Future Tek's Model 6000 Conveyor Trainer provides extensive "real-world" motor controls training. Delivered completely assembled and loaded with demonstration programs.

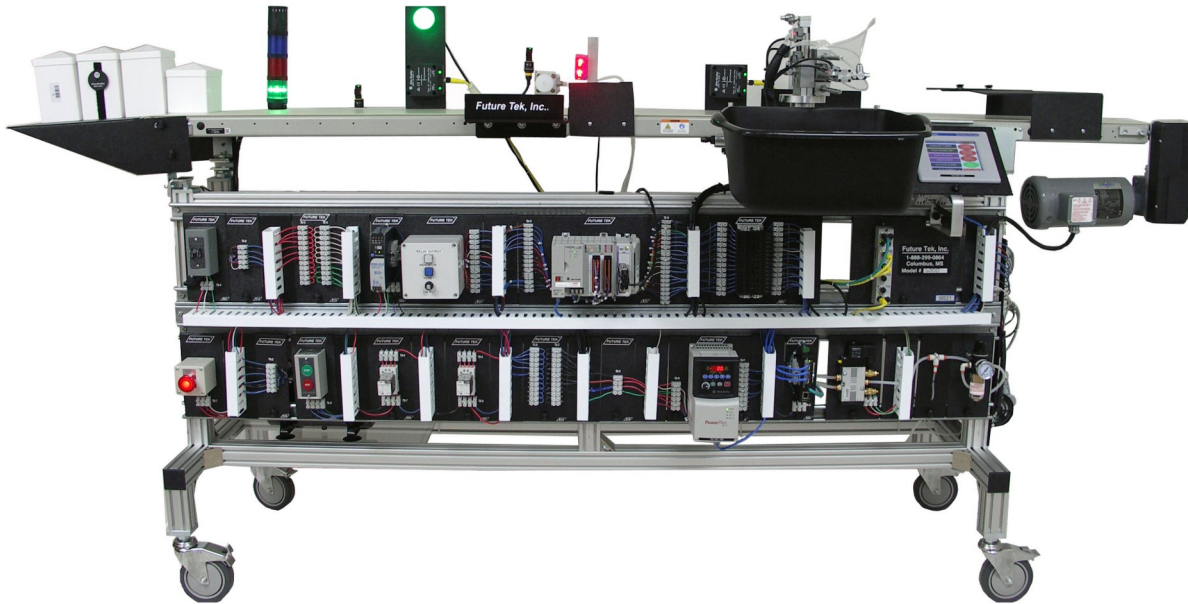

### The Conveyor Unit Provides Hands-on Training For:

- Variable Frequency Drive
- Pneumatics
- Robotics
- Motor Control
- Conveyor
- Industrial Wiring
- HMI
- HMI Software
- PLCs
- RSLogix Software
- Mechanical Systems

### Standard System Includes:

- Allen Bradley CompactLogix L24 PLC
- E-Stop
- Main Power/Lockout Station
- Start/Stop Station
- Indicator Station (Tower Light)
- EtherNet Hub
- Rightsight Photo Switches
- Output Relay Indicator Light
- Control Relays
- Selector Switch
- Potentiometer
- PowerFlex 525 Variable Speed Drive
- 3-Phase Motor with Gear Reduction
- Pneumatic Kick-off Cylinder
- Solenoid Valve
- Air Regulator with Filter
- Air Compressor



## Conveyor Trainers

### Other Units Include:

- 6000 Conveyor System with Allen-Bradley Micrologix 1400 Processor
- L24-CE Conveyor System with Allen-Bradley CompactLogix Processor with EtherNet
- 6000-S1200 Conveyor System with Siemens 1200 Series Processor

### Optional PLCs Include:

- Allen-Bradley Micrologix 1400 PLC (6000 Conveyor)
- Siemens 1200 Series (6000-S1200 Conveyor)

### Optional Components Include:

- Pick and Place Robot
- Barcode Scanner
- 700 Color PanelView with EtherNet
- Siemens HMI
- Radio Frequency Identification Device (RFID)





## Mechanical Trainers

### 3000 Series

Future Tek's line of Mechanical Trainers are large, industrial strength models built to last for years to come. Each trainer includes curriculum and required accessories to complete the hands-on lab exercises.

- Belt Drive Trainer (Model 3001)
- Chain Drive Trainer (Model 3002)
- Shaft/Drive Coupling Alignment Trainer (Model 3003)
- Bearing Maintenance Trainer (Model 3004)
- Pump Maintenance Trainer (Model 3005)
- Pump Drive Trainer (Model 3006)
- Pneumatic Clutch and Brake Trainer (Model 3007-P)

### Curriculum Topics:

- Identify Belt and Chain Drive Components
- Install and Adjust Belt and Chain Drives
- Calculate Drive Ratio and Sprocket Size
- Measure/Correct Soft Foot
- Measure for Shaft Run-out
- Determine Bar Sag
- Use Straight edges, Feeler Gauges, and Two Dial indicators to Perform Alignment
- Use a Graph to Perform an Alignment
- Use Two Dials to Perform a Reverse Dial Alignment
- Bearing Identification and Mounting
- Bearing Lubrication
- Reduction or Internal Clearance Exercises
- Use of Mounting and Dismounting Sleeves
- Pump Disassembly
- Flow Meters
- GPM
- PSI
- Cavitations
- Liquid End Disassembly/Reassembly
- Coupling End Frame Disassembly/Reassembly
- Impeller Adjustment
- Centrifugal and Positive Displacement Pumps
- Priming
- Sheave and Bushing Alignment
- Mounting and removing QD Bushing and Sheaves
- Basic Air Controlled Industrial
- Clutch and Simple Braking Load





**3001**

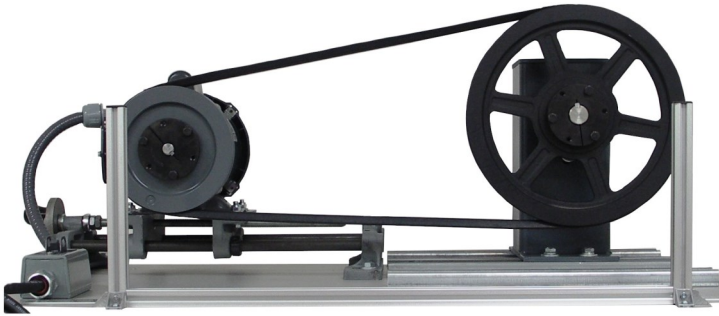

**3002**

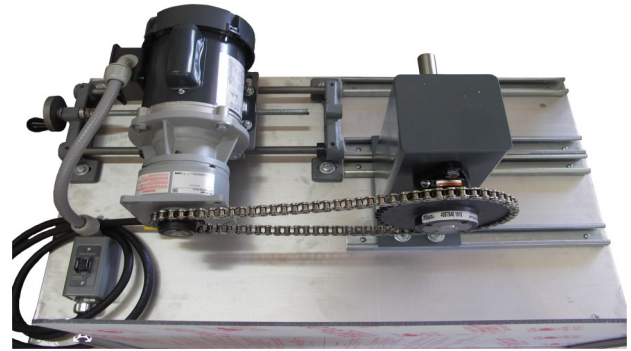

**3003**

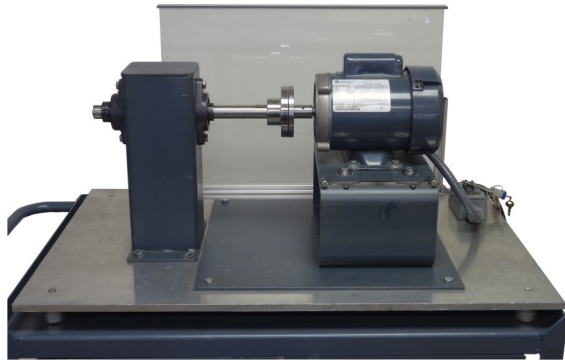

**3004**

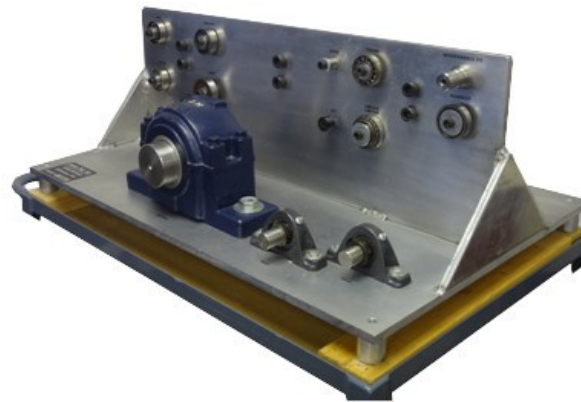

**3006**



**3005**

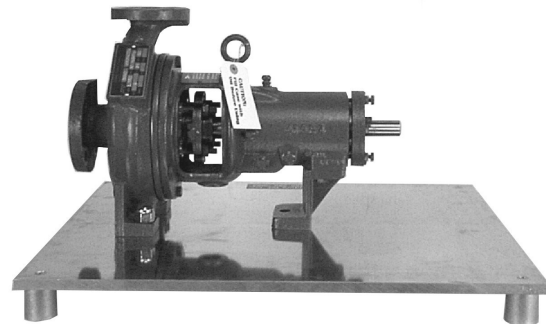

**3007-P**

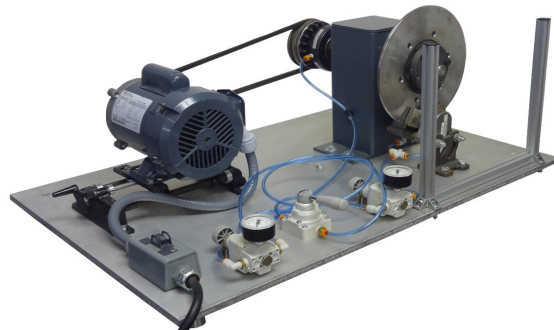

## Transformer Trainer

### Model 2515

Future Tek's Model 2515 Transformer Trainer provides hands-on, "Real-World" exercises covering:

- Single-Phase Transformers
- Buck-Boost Transformers
- Transformer Polarity
- Autotransformers
- Three-Phase Transformers
- Closing a Delta
- Open Delta

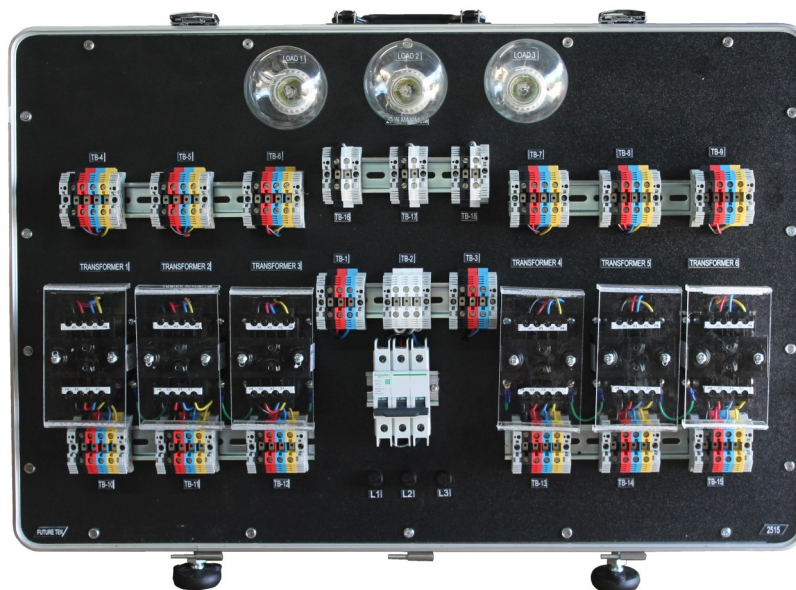

### Components Included:

- (6) 0.75 kVA Transformers
- (3) 25 Watt Bulbs
- Three-Phase Circuit Breaker
- 208 VAC Three-Phase five (5) wire source voltage twist lock male receptacle
- 15' Five Conductor SO Cable with twist lock female receptacle
- (18) Terminal Blocks
- Terminating Screw Driver



## Pneumatic Trainers

### 8500 Series

Future Tek offers Pneumatic Trainers in large upright floor models mounted on roll around carts (Models 8501 & 8502) and in sturdy cases (Models 8503 & 8505) with removable covers.

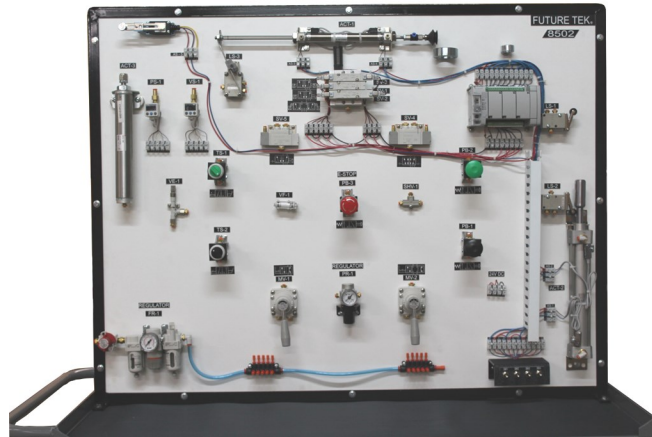
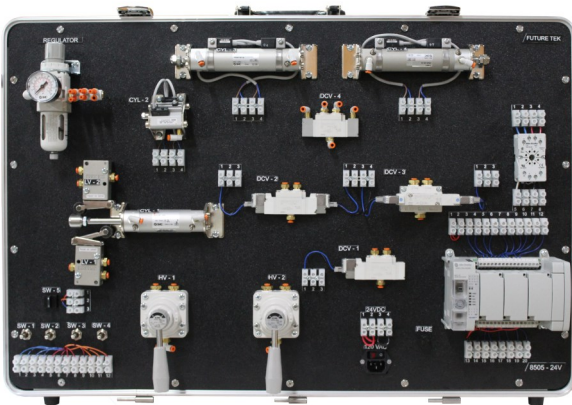

### Curriculum Topics:

- Fluid Power Primer
- Fluid Power Symbols
- Basic Circuit Diagrams Safety
- Single-Acting Cylinder (Manual)
- Double-Acting Cylinder (Manual)
- Limit Valve Operation (Manual)
- 4/2 Manual DCV & Two (2) 3/2 Limit Valves (Manual)
- Flow Control (Manual)
- Pilot Operated DCV
- Limit Valve (Pilot Operation)
- Reciprocation Circuit (Pilot)
- Multiple Actuators (Pilot)
- Multiple Cylinder Flow Control (Pilot)
- Cylinder Cushion Adjustment
- Cylinder Extension/Retraction Velocity
- Regeneration
- Electrical Wiring and Devices
- Single Solenoid DCV Control
- Dual Solenoid DCV Operation
- 5/3 Dual Solenoid DCV

- Single and Dual-Solenoid DCVs
- Multiple Actuators
- Autoswitch Control
- Pneumatic Logic Valves
- Student Designed Circuit

### PLC Control

- Pre-Wiring of Inputs and Outputs
- XIC XIO Instructions
- Hold In Lab
- Latch/Unlatch
- One Shot
- Position and Hold
- Timer On
- Loop 1
- Timer Off
- Sensor Control Cycle
- Sequencer

## Hydraulic Trainers

### 9500 Series

Future Tek offers Hydraulic Trainers in large upright floor models mounted on roll around carts (Models 9501 & 9502) and in sturdy cases (Models 9503 & 9505) with removable covers.

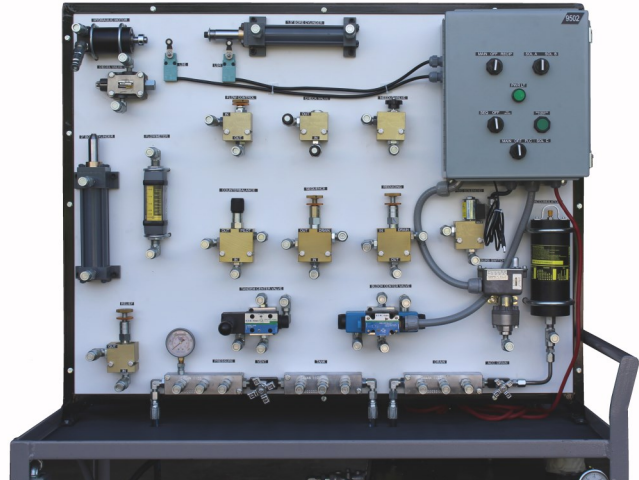
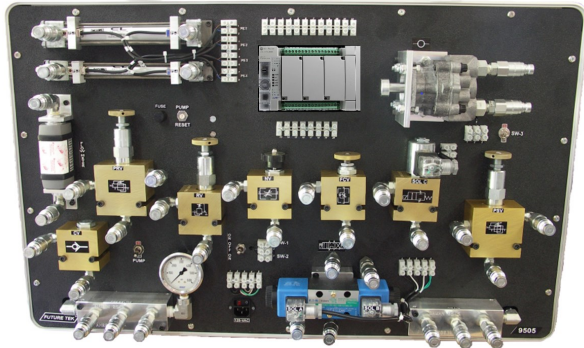

### Curriculum Topics:

- Familiarization and Pump Troubleshooting
  - Flow
  - Pressure Caused by Restriction
  - Aeration
  - Cavitations
- Cylinder Circuits
  - Directional Control
  - Speed Control
  - Force Control
  - Series Control
  - Parallel Circuit
  - Regenerative Circuit
  - Counterbalance Circuit
  - Speed Increase with Accumulator
- PLC Control
- Hydraulic Motor Circuits
  - Directional Control
  - Speed Control
  - Brake Circuit
  - Sequencing Circuit
- Accumulator
  - Unloading Circuit
  - Dumping Circuit
- Electrical Controlled Cylinder Circuits
  - Directional Control
  - Reciprocating Circuit
  - Dual Pressure Circuit
  - Safety Circuit
  - Sequencing Circuit
- Electrical Controlled Motor Circuits
  - Directional Control
  - Safety Circuit
  - Sequencing Circuit
- Electrical Accumulator Unloading Pressure Switch



## Process Technology

### 6500 Series

Learn to control Pressure, Flow, Temperature, and Level by performing Hands-on laboratory experiments covering SetPoint Adjustment, Proportional Control, Integral Control, and Derivative Control.

Level II includes a PLC, PanelView, and a Variable Frequency Drive and is available in two (2) different configurations:

6500-II-C contains an A-B CompactLogix PLC which utilizes Studio 5000 Software

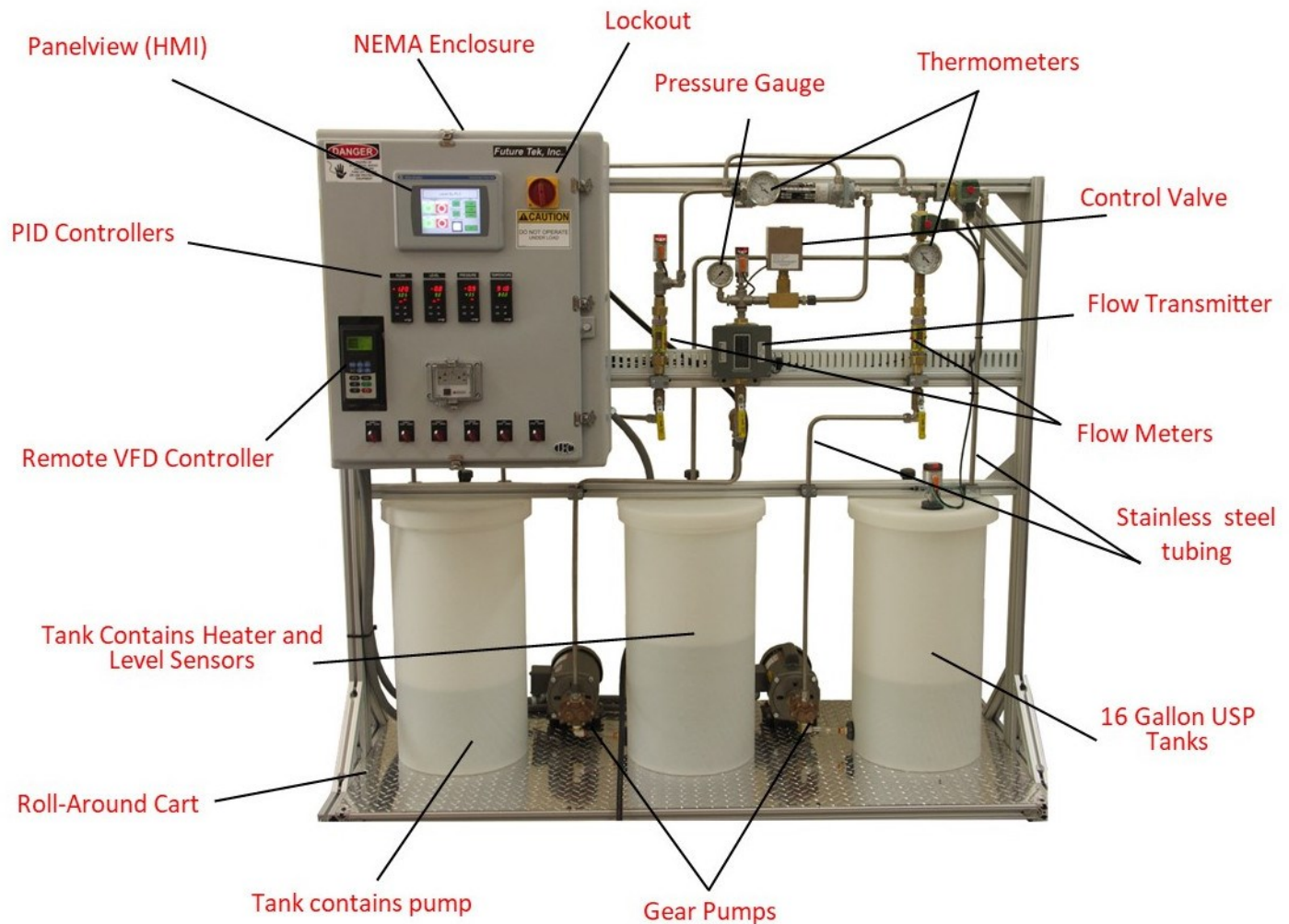

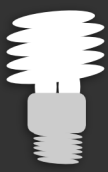

## **Future Tek Train the Trainer Program**

Future Tek offers training classes utilizing our equipment. Our primary instructor, Lee Trent, has 16 years experience as an industrial Electricity/Electronics Instructor, 10 years as an Electrician/Job Supervisor in Residential/Commercial/Industrial Construction, and 6 years as a High Voltage Equipment/Substation Technician.

Training sessions are typically 20 hours (2 1/2 days) and may be customized to meet your requirements. These are available onsite or here at our Columbus, MS facility. Please call for pricing and scheduling information.

Demonstration sessions may also be scheduled to include any of our training systems



## **Voltage Requirements for Future Tek Training Systems**

### **Single-Phase/ 120 Volts**

PLC Training Systems  
Residential/Commercial Lighting Trainer (2000-WS)  
Relay Ladder Logic Trainers (2100 Series)  
Conveyor System (Model L24)  
HVAC Training System (Models 4210)  
Single-Phase Motor Controls Package (Model 7000-S)  
Home Security Trainer (Model 4000)  
Commercial/Industrial Fire Alarm Trainer (Model 4200)  
Mechanical Trainers (3000 Series)  
Pneumatic Trainers (8500 Series)  
Hydraulic Trainers (9500 Series)

### **Single-Phase/ 240 Volts**

Process Control Training Systems (6500 Series)  
Residential Wiring Trainers (Models 1800, 8000, 8000-TS)

### **Three-Phase/ 208 Volts**

Transformer Trainer (Model 2515)  
Three-Phase Motor Controls Trainer (Model 7000, 7000-TS)  
Commercial Industrial Wiring Training Systems (Model 9000, CWT Series, and MCT)



# **Future Tek Inc.**®

663 South Frontage Rd Columbus, MS 39701  
Office: 888-299-0864 662-328-0900  
Fax: 662-328-8584 info@futuretekinc.com  
www.futuretekinc.com

**Catalog 2024 Edition**